

modular/panel-built sauna kit

installation instructions



Please immediately check for any hidden damage that may have occurred in shipping. If any damage is found you must notify the delivering carrier within seven days.

A few minutes with the following instructions will insure quick and proper assembly, and many years of enjoyment and relaxation. By reviewing all the instruction steps ahead of time, you will have a better feel for the whole process.

Your sauna package will arrive on a stretch-wrapped pallet including a stack of pre-built panels, benches, and boxes with the heater and accessories.



Your sauna can be placed on concrete, tile, linoleum, or any surface that does not absorb water. Do not install the sauna on carpeting.

Tools Required

- Hammer or pin nailer
- Handsaw and mitre box (for molding installation & vent holes)
- Drill or cordless screwdriver
- Tape measure
- Square
- Level
- 3/8" wood bit (if sauna room has an L-bench)
- Note: Torx bit is provided

Accessories

*Styles may vary based on Interior & Designer Series.



Duckboard

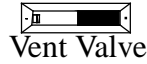

Vent Valve

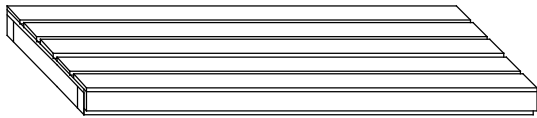

Benches

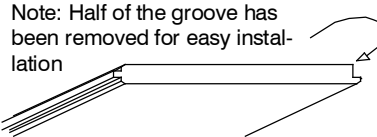

Note: Half of the groove has been removed for easy installation

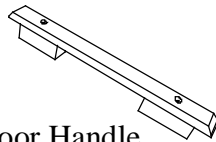

Door Handle

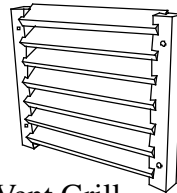

Vent Grill

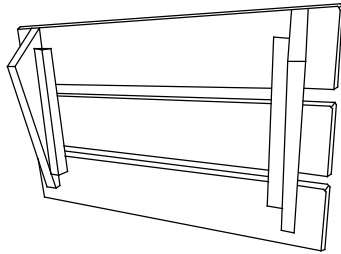

Standard Headrest

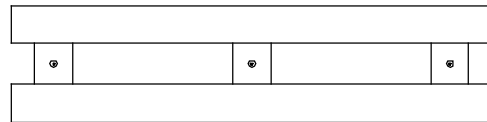

Backrest

Trim Profiles



Cove Molding



Window/Door Casing
(normally pre-installed)



Inside Corner Molding



Exterior Facia Trim
(in some models)

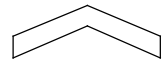

Outer 45 Deg. Corner Molding
(on rooms w/more than 4 walls)

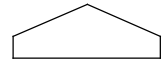

Inside 45 Deg. Corner Molding
(on rooms w/more than 4 walls)

Hardware Package



2" Screws

1-1/2" Screws

Carriage Bolts

(for saunas with L-benches)

Washers & Nuts

Finishing Nails

3" Screws

Torx Bit

Wood Joiners

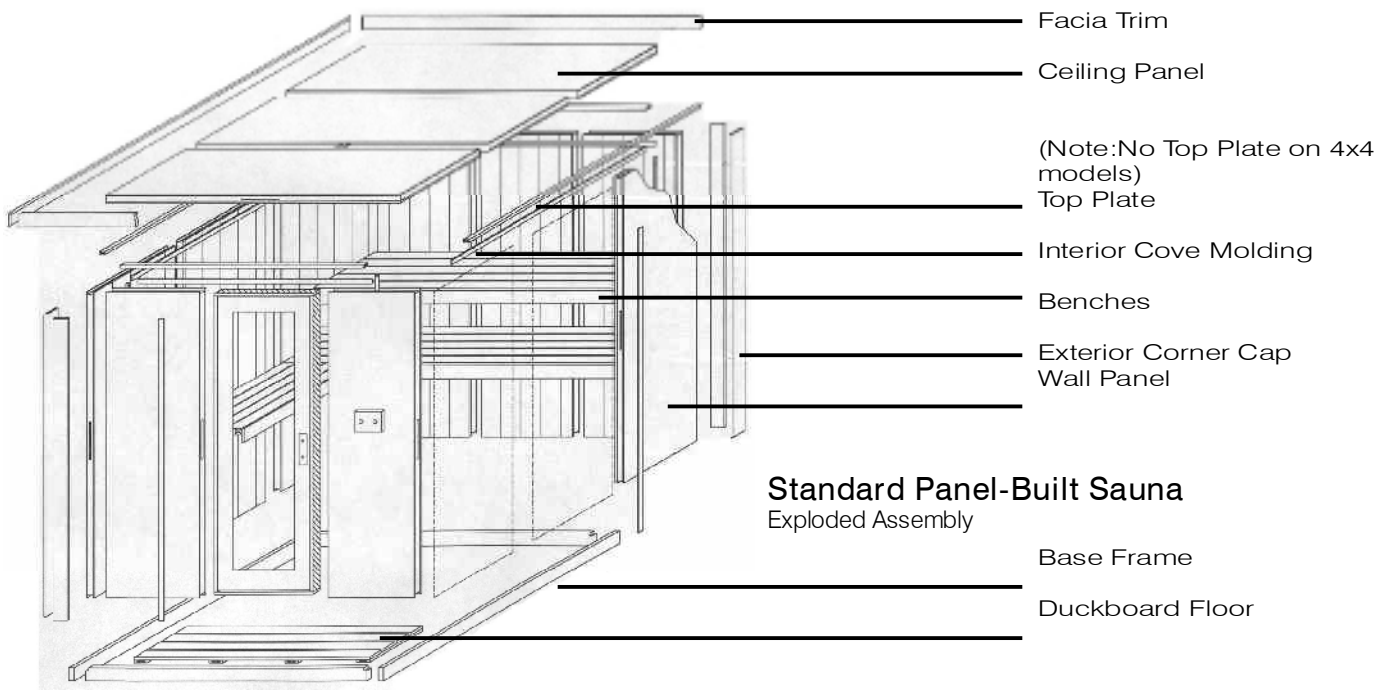

Note: Base rail, top rail & trim are all labeled.

Base Frame Assembly

If the sauna is to be positioned close to a wall or corner, start assembly away from the wall and once the rear panels are installed push the sauna into place.

- 1 Position the base frame on the floor (photo A). The largest number on the base frame is the standard door location. The stamped numbers on the base frame should be readable from inside of the room and correspond to the wall panels that will be placed on them in a later step.
- 2 The air inlet has been installed below the heater location.
- 3 Using one three-inch screw at each corner and the pre-drilled holes, fasten the corners of the base frame (photo B).
Note: The pre-drilled holes are purposely made at an angle.
- 4 Using a level and a square, make sure the base frame is square and level. Shim it where needed with standard shims.



Wall Panel Installation

If the sauna is to be placed against existing wall(s), panel installation should begin at these sides. After these panels are in place, the sauna can be slid back towards the wall(s) keeping it 1/2" to 1" away.

All wall panels are numbered at the top and should be readable from the interior of the room. These numbers will coincide with the numbers on the base frame. **NOTE:** The tongue and groove on the panels will always face the same direction.



5 Start your wall panel assembly in a corner. **NOTE:** It is not always necessary to install your panels in sequence according to their numbers. Two wall panels make up each corner. Slide one panel along the base frame until its 2x2 framework is flush with the outside of the base frame (diagram A, panel 3).

NOTE: For ease in installing the panels, tilt the top of each panel back to get the tongue and groove alignment started. Then tilt forward for an easy fit.

6 Have someone hold the first panel in place and then put the other corner panel on the base frame and slide it tight into the corner so its 2x2 framework butts up against the framework of the other panel (panel 4 from diagram A).

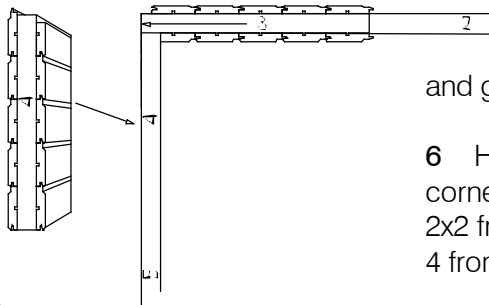

diagram A

*There are 2 methods for fastening your wall panels ...

Exterior (Standard): To be followed when there is easy access to all exterior corners of the sauna. See diagram B and follow steps 7A & 8A.

Interior (Alternate): When room was ordered as "Interior Install". See Diagram C and follow steps 7B & 8B.

7A Fasten the two panels together from the outside of the room using 3" torx screws. Holes are pre-drilled.

8A Install exterior, pre-assembled corner trim with provided #4 finishing nails. (photo D). **NOTE:** One side of the groove has been removed for easy installation.

7B Fasten the two panels together from the inside of the room using 3" torx screws. Angled holes are pre-drilled.

8B Install the removed interior tongue & groove using #4 finishing nails. **NOTE:** If exterior corner is exposed install exterior, pre-assembled corner trim with provided #4 finishing nails. (photo D)

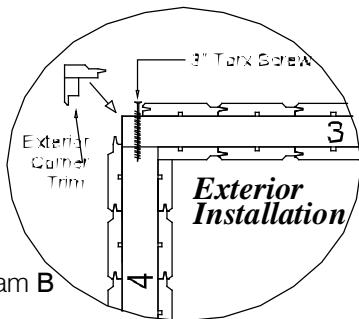

diagram B

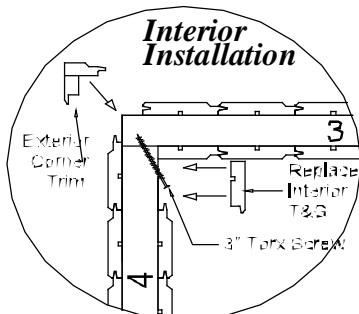

diagram C

710-0107 Panel Built Installation
Rev. 02



9 Continue setting the panels into place as marked. Use the barbed wood fasteners to join the tops of the panels (photo E).

IMPORTANT: If you are in a low ceiling height situation (space above sauna is less than 3"). You must put the top plate and ceiling panels in before installing the front wall panels as described in step 10 method B.

NOTE: The door panel should be installed before your last corner panel is put in place. Use two people to move it as it is quite heavy.

Top Plate Installation

After installing the wall panels, the next step is to assemble and install the top plate (sometimes referred to as the "ceiling frame"). This top plate aligns and locks the top of the wall panels together.

There are 2 methods for fastening your top plate ...

Standard: To be followed when there is easy access to the top of the sauna.

Alternate: To be followed when access to the top of the sauna is limited.

10a (Standard):

In most installations it is easier to install the top plate one piece at a time, rather than pre-assembling it on the floor. To do so, install the sections onto the front and back wall with the notched ends facing up (photo F). Then put the side pieces of the plate into place. Firmly press it down (use a hammer if needed) until it rests on the framework of the wall panels. The top of the plate should be flush with the top of the interior tongue and groove. Fasten with one 2" screw in each corner (photo G).

10b (Alternate): (Especially needed for low ceiling heights)

Layout all pieces of your top plate on the floor. Using one 1" screw in each corner, fasten all corners together then drop the top plate into place along the top of the wall panels. Firmly press it down, using a hammer if needed, until it rests on the framework of the wall panels. The top of the plate should be flush with the top of the interior tongue and groove.

11 Install the provided foam tape along top plate to give a better seal once the ceiling panels are installed. Tape should be centered on the top plate and will encircle the entire room.

Ceiling Panel Installation

Low Height Installation Tip: If the clearance above the sauna is less than 3", the ceiling panels should be installed prior to the front wall panels.

12 With one person inside the sauna room and another outside, feed the ceiling panels over the top of the walls being very careful not to scratch the panels (photo H). When in position, they will rest on the top plate.

13 In the case of more than one ceiling panel, adjoin the panels as shown. Lift the panels together, then lower at the same time allowing the tongue and groove to lock together (photo I).

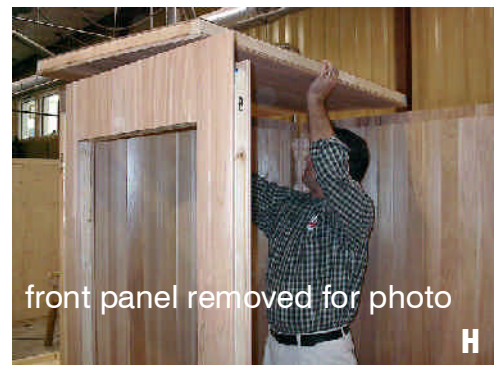
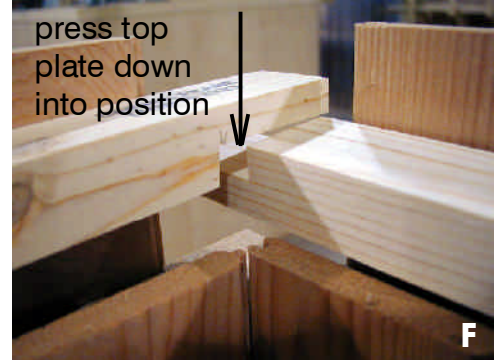
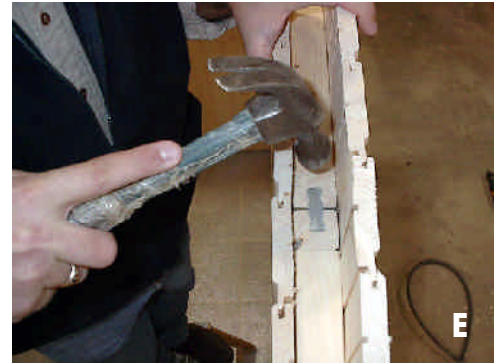



Cove Molding Installation

14 The cove molding (3/4" x 1") will be provided longer than needed to allow trimming to exact size to insure a tight fit. Measure each wall to determine cut length. A simple butt-end cut is the easiest. Cut molding straight, then butt the pieces together (photo J). If you prefer a mitre joint, the molding is long enough to accommodate that type of cut as well.

15 Using #4 finishing nails (Pneumatic nailer preferred), nail the cove molding to the interior walls.

16 Once the molding is secured to the walls nail it through the bottom & into the ceiling to help keep it in place.

Vent Valve and Vent Grill are Pre-Installed.

Bench Installation

In standard cases, the benches are positioned with the upper bench against the back wall of the sauna, and the lower bench parallel to it. There are four bench support boards: two that are 23" long for the upper bench, and two that are 45" long (length can vary with sauna model), for the lower bench. This extended length will allow the lower bench to slide under the top bench for ease in cleaning. Bench configuration will most likely be different with custom designed rooms.

NOTE: In most cases the bench supports are pre-installed. If not, the interior walls have been marked at the heights you should attach the bench supports, generally top bench support at 30" and lower bench support at 12" off the floor. **These are the heights of the top edge of the bench supports, not the top of the benches!**

19 Position the bench supports about 1/4" away from the back walls. Making sure they are level, use 3" screws and pre-drilled holes to secure the bench supports to the walls (photo K). Be sure to install screws in all the pre-drilled holes. When installed at the height noted, the 3" screws will line up with the internal framing of the panels for necessary strength.

20 Install the benches, starting with the bottom bench first. Note that one side of the bench is finished, while the other has exposed framing. (This may vary with custom designed rooms). The bench should be installed with the finished face forward. Unless instructed otherwise, the benches do not need to be fastened to the walls. This will allow for ease in cleaning. However, if you desire no moveability of benches, fasten the benches directly to the wall using 3" screws through the 2x4 bench framework (the bench supports should still be used).

NOTE: Two 3/8" holes have been drilled through the frame of the upper L-bench. With the top of the benches aligned, use a 3/8" drill bit and drill through the 2 provided holes and through the face of the main upper bench. Bolt the two benches together using the 5-1/2" carriage bolts provided (photo L). **Custom designed rooms may have a different bench configuration.**

Backrest Installation

Some sauna models include backrests. Actual installation height will vary, depending upon the height of the sauna owner/user. Position it so the backrest is in the mid-back/shoulder blade area... whatever feels most comfortable. A standard height is 20" from top of bench to top of backrest.

21 Making sure it is level, hold the backrest at your preferred height, fasten it to the wall through the predrilled holes, using 2" screws (photo M). Wood plugs are provided to cover the exposed screw head.

22 Repeat step 25 if more than one backrest is included. Typically one backrest for each upper bench is included.

Exterior Facia Installation

NOTE: Do not install the facia until your heater is wired since the electrical access board may need to be removed.

23 The facia can be installed using simple butt-end cuts, or with mitre cuts. If using butt-end joints, cut the side wall facia the same length as the side walls (photo N). Using the provided galvanized finishing nails, fasten with the top edge of the facia flush with the top edge of the ceiling panel. The front facia should be cut to overlap the side facia. Install flush with top of ceiling panel.

Heater Guard Installation

24 Place the heater guard around the heater as described in your heater instructions. Spacing may vary according to heater kilowatt.

NOTE: The front rails of the 2-sided heater guard can be cut to desired length before assembly.

Interior Light Installation

25 The light should be wired by a licensed electrician according to local codes. The light can be mounted on a wall of your choice. If you plan to use the corner lampshade, then the light will need to be installed tightly into a corner, 4" down from the cove molding (photo O). Otherwise, off to one side of the door is most common.

Sauna Heater Installation

26 The heater should be wired by a licensed electrician according to the specifications provided with the heater. One of the wall panels has a removable board to allow for wiring access to the heater (photo P). This tongue and groove board is located in the trim package. After the wiring is completed, attach the board with the galvanized nails provided in the hardware pack.

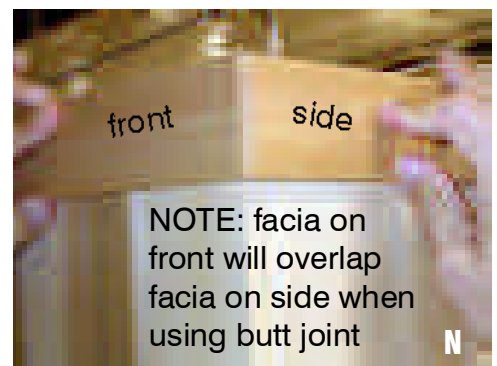
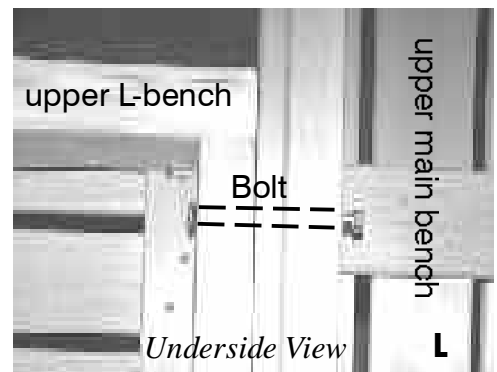

Rock Placement (Very Important)

27 Rinse the rocks before placing them in the sauna heater. Place the smaller and flatter rocks around the outside of the rock compartment and the larger rocks in the center (photo Q). This will allow for good air transfer through the heater. Do not try to force all the rocks in, It is important to have space between the rocks to give optimum heater performance, faster heat-up time and higher temperatures. Save your extra rocks for replacements.

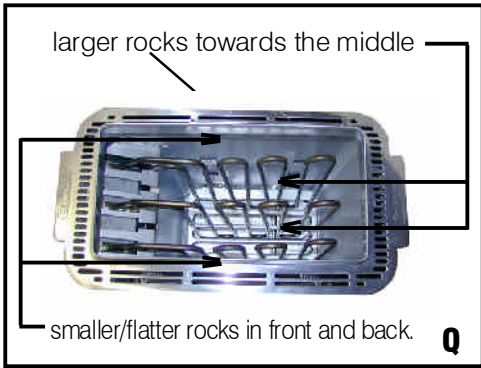

Door Handle Installation

A pair of door handles is provided with each door. (Styles vary)

28 Using the screws provided, install the door handles with the center of the handle approximately 36" off the floor, or whatever height is most comfortable (photo R). After the handles are fastened, install the provided wood plugs to fill the holes.

