



AMEREC K200i CONTROL SYSTEM (FOR USE WITH AMEREC AK AND 3K MODEL GENERATORS)

FOR THE SAFETY OF YOU AND YOUR FAMILY PLEASE READ THE WARNINGS TO THE RIGHT AND ALL INSTRUCTIONS BEFORE USING YOUR STEAMBATH.

POST "WARNING" LABEL OUTSIDE STEAM BATH FOR SAFETY WARNINGS. REQUIRED POSTING ON DOOR OF STEAM ROOM OR ADJACENT TO DOOR FOR ALL COMMERCIAL INSTALLATIONS.

DUAL INSTALLATIONS REQUIREMENT

If two K200i systems are installed within 50 feet, they have the potential of interfering with each other. For these situations an alternate frequency K200i ("B" version) system must be specified for purchase.

SAVE THIS MANUAL

Thank you for purchasing your new Amerec steam generator. If we can be of any assistance do not hesitate to call our Technical Support at 1-800-363-0251.

WARNING

Electric Shock Hazard - High voltage exists within this equipment. There are no user serviceable parts in this equipment. All installation and service to this equipment should be performed by qualified licensed personnel.

Do not exceed 30 minutes in a steam bath. Excessive exposure can be harmful to your health. Excessive exposure can produce a rapid pulse, light-headedness, weakness or fainting. If you become uncomfortable or experience any of the above conditions exit the steambath immediately.

Steam baths can put stress on the body. Therefore a steambath should be used only under a doctor's direction if you:

- Are pregnant*
- Have a heart condition*
- Have high blood pressure*
- Have circulatory problems*
- Are under the influence of alcohol*
- Are under the influence of drugs*
- Have diabetes*
- Are under the care of a physician*
- Are in generally poor health*

Children should only use the steam bath under close adult supervision.

Scald Hazard: Do Not Touch the steam head or trim during operation as they are HOT. Stay at least 12 inches away from the hot steam escaping from the steam head.

Be careful when entering a steam bath. Escaping steam from an overheated steam room may cause injury.

⚠ WARNING

REDUCE THE RISK OF OVERHEATING AND SCALDING

1. Exit immediately if uncomfortable, dizzy or sleepy. Staying too long in a heated area is capable of causing overheating.
2. Supervise children at all times.
3. Check with a doctor before use if pregnant, diabetic, in poor health or under medical care.
4. Breathing heated air in conjunction with consumption of alcohol, drugs or medication is capable of causing unconsciousness.
Do not contact steam head. Stay at least 12" away from hot steam escaping from the steam outlet.

CAUTION!

REDUCE THE RISK OF SLIPPING AND FALL INJURY

Use care when entering or exiting the steam room, floor may be slippery.

NOTE: For additional safety instructions, see owner's manual.



IMPORTANT SAFETY INSTRUCTIONS

1. READ AND FOLLOW ALL INSTRUCTIONS.
2. WARNING - To reduce the risk of injury, do not permit children to use this product unless they are closely supervised at all times.
3. WARNING - To reduce the risk of injury:
 - a. The wet surfaces of steam enclosures may be slippery. Use care when entering or leaving.
 - b. The steam head is hot. Do not touch the steam head and avoid the steam near the steam head.
 - c. Prolonged use of the steam system can raise excessively the internal human body temperature and impair the body's ability to regulate its internal temperature (hyperthermia). Limit your use of steam to 10 - 15 minutes until you are certain of your body's reaction.
 - d. Excessive temperatures have a high potential for causing fetal damage during the early months of pregnancy. Pregnant or possibly pregnant women should consult a physician regarding correct exposure.
 - e. Obese persons and persons with a history of heart disease, low or high blood pressure, circulatory system problems, or diabetes should consult a physician before using a steam bath.
 - f. Persons using medication should consult a physician before using a steam bath since some medication may induce drowsiness while other medications may affect heart rate, blood pressure and circulation.
4. WARNING - Hyperthermia occurs when the internal temperature of the body reaches a level several degrees above the normal body temperature of 98.6°F. The symptoms of hyperthermia include an increase in the internal temperature of the body, dizziness, lethargy, drowsiness and fainting. The effects of hyperthermia include:
 - a. Failure to perceive heat:
 - b. Failure to recognize the need to exit the steam bath:
 - c. Unawareness of impending risk:
 - d. Fetal damage in pregnant women:
 - e. Physical inability to exit the steam bath: and
 - f. Unconsciousness.

WARNING - The use of alcohol, drugs or medication can greatly increase the risk of hyperthermia.

SAVE THESE INSTRUCTIONS

This equipment has been tested and found to comply with the limits for a Class B digital device, pursuant to Part 15 of the FCC Rules. These limits are designed to provide reasonable protection against harmful interference in a residential installation. This equipment generates, uses and can radiate radio frequency energy and, if not installed and used in accordance with the instructions, may cause harmful interference to radio communications. However, there is no guarantee that interference will not occur in a particular installation. If this equipment does cause harmful interference to radio or television reception, which can be determined by turning the equipment off and on, the user is encouraged to try to correct the interference by one or more of the following measures:

- Reorient or relocate the receiving antenna.
- Increase the separation between the equipment and receiver.
- Connect the equipment into an outlet on a circuit different from that to which the receiver is connected.
- Consult the dealer or an experienced radio/TV technician for help.

Changes or modifications not expressly approved by Saunatec Inc. may void the user's authority to operate this equipment.

These devices comply with Part 15 of the FCC Rules. Operation is subject to the following two conditions: (1) these devices may not cause harmful interference, and (2) these devices must accept any interference received, including interference that may cause undesired operation.

These Class B digital apparatuses comply with Canadian ICES-003.

Ces appareils numérique de la classe B est conforme à la norme NMB-003 du Canada.

Device	Model Number		
Remote Control	K200i-RC	FCC ID: WKGK200RC	IC: 7858A-K200RC
Remote Control Dock	K200i-DK	FCC ID: WKGK200DK	IC: 7858A-K200DK
RF Hub	K200i-HB	FCC ID: WKGK200HB	IC: 7858A-K200HB

SECTION 1: K200i CONTROL SYSTEM OVERVIEW

The K200i control is a radio frequency (RF) control system which includes a **remote control, remote control dock,** and **RF communication hub.** As options, the features of aromatherapy (scent therapy); chromatherapy (colored light therapy) and “Even Steam™” heat circulation fan can be added to the system and operated using the remote control.

The **remote control** communicates with the steam generator by sending and receiving signals from the RF hub and can be operated either inside or outside the steam bath. Using the keypad and icons on the display screen, the standard settings of temperature, steam bath duration and time of day can be controlled. Additionally the remote controls advanced settings of Celcius or Fahrenheit display, 60 minute or 24 hour operation, custom user profiles #1 or #2, warm start (preheats water in steam tank for faster start-up time) and automatic start time for weekday or weekend operation. The remote control comes with a battery charger and battery which can hold a charge for multiple steam bath operations. Depending on location and surrounding construction, the remote can operate up to 50 feet from the RF communication hub connected to the generator.

The **remote control dock** mounts inside the steam room, acts as a dock for the remote control, includes a built in temperature sensor, an on / off button for starting or stopping the steam bath if the remote is not available and a blinking LED light which indicates if the steam bath is on or off during the “on” cycle. The dock includes a replaceable long life battery (should last several years) and should be mounted four feet up from the floor (not directly over the steam head) to properly sense the room temperature.

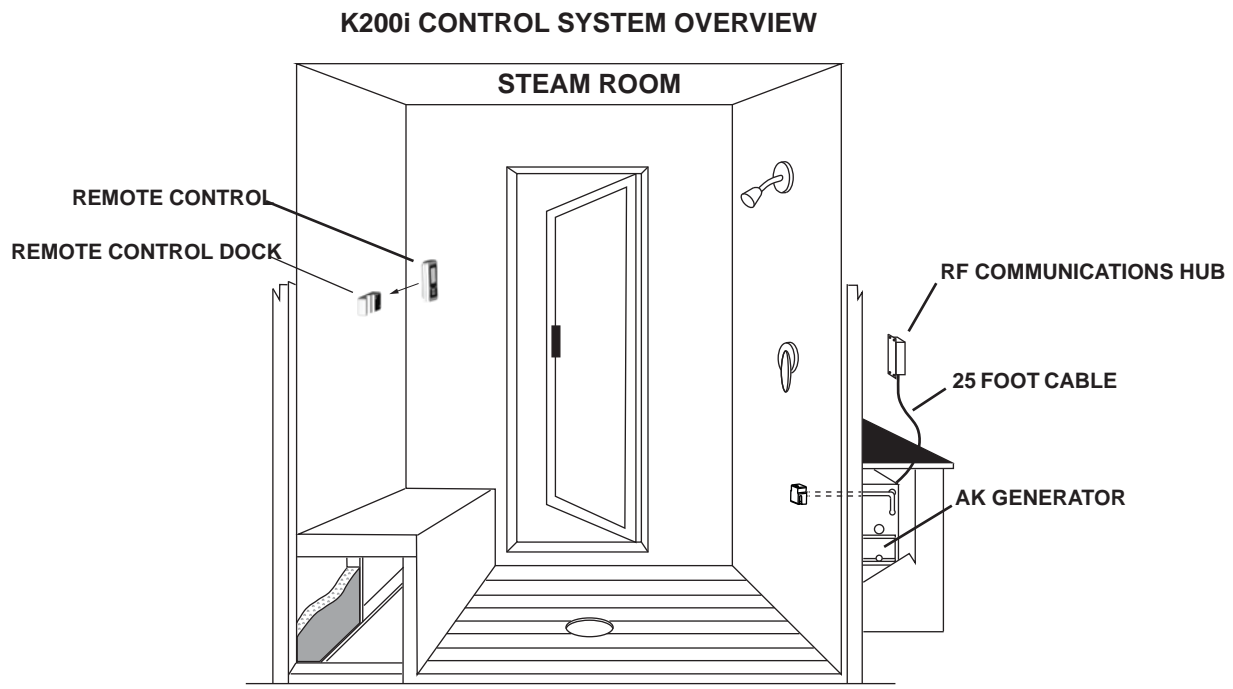

SECTION 2: K200i REMOTE OPERATION

To start the remote display, push any button on the remote. The start up logo appears in 2 seconds followed by the main menu. (pushing any button once the start up logo is displayed, will take you immediately to the main menu without delay). The remote display stays lit for 30 seconds after the last button push, then goes into a battery conservation sleep mode. To restart or wake up the display, push any button on the remote. The remote control is programmed by selecting function icons using the up, down, left and right arrows on the key pad and then locking in the setting desired by pushing the “select / enter” center button. The “select / enter” center button can be pressed at any time to lock in any previous adjustments and return to the prior menu.

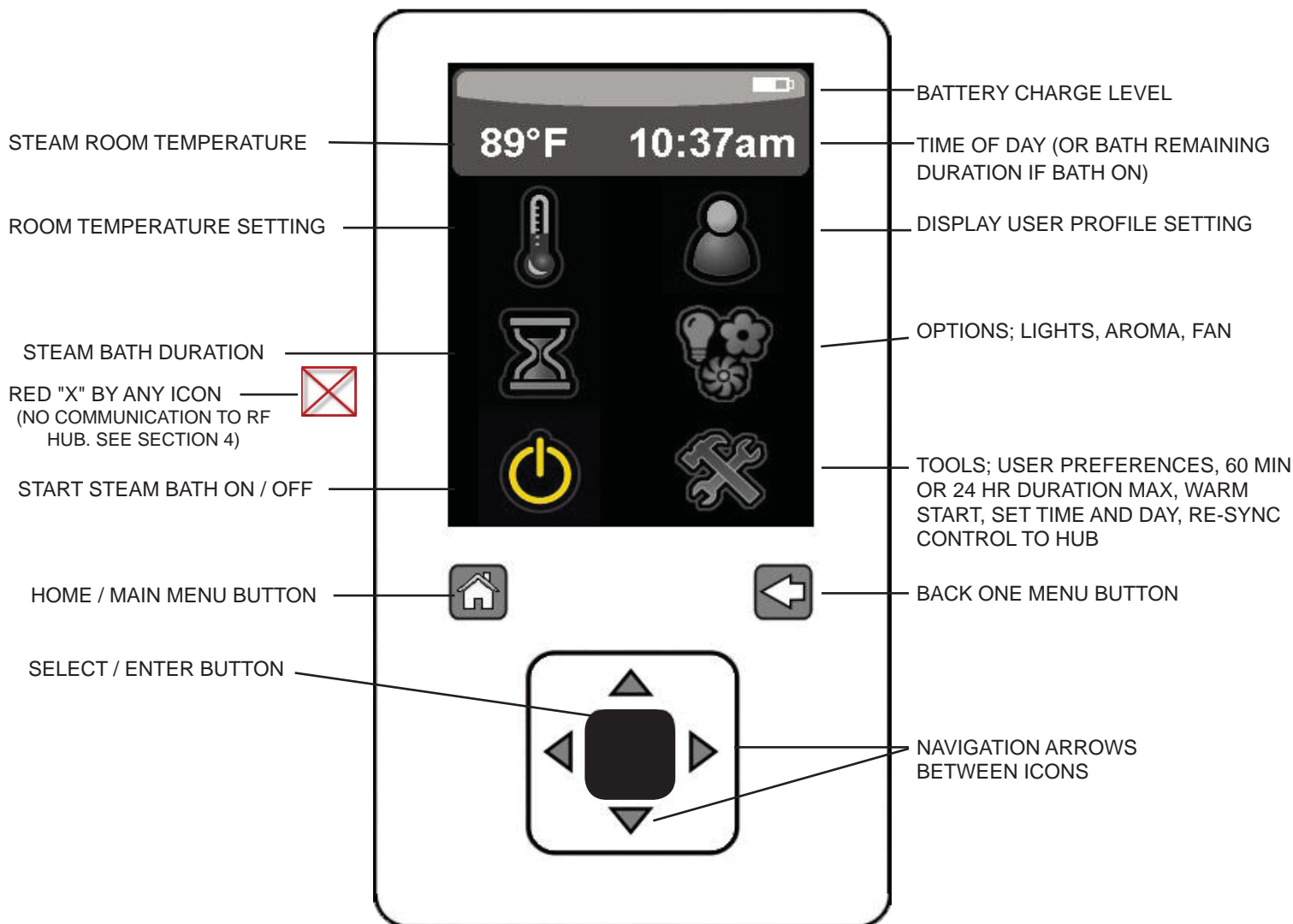

START THE STEAM BATH CYCLE

With the “start steam bath on / off” icon highlighted press the “SELECT / ENTER” button to start the bath cycle with the last settings used or set. (If a Red  appears next to the on/off icon, it indicates the remote control or dock are not receiving a signal from the RF Hub. If this occurs, move the remote control closer to the RF Hub or change the location of the RF Hub. It takes approximately 10 seconds to re-establish connection once it is lost and then available again).



SET TEMPERATURE

From the main menu use the up arrow to highlight the thermometer, then press the “SELECT / ENTER” button.



The menu below will appear. Use the UP or DOWN arrows to increase or decrease the set temperature. If desired, use the left or right arrows to change from Fahrenheit to Celsius. Once the desired settings are displayed press the "SELECT / ENTER" button to lock in the setting.

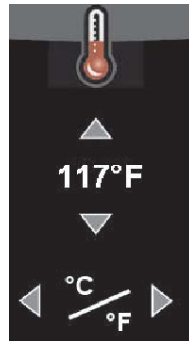

SET STEAMBATH DURATION

From the main menu use the up arrow to highlight the hour glass, then press the "SELECT / ENTER" button.



The menu below will appear. Use the UP or DOWN arrows to increase or decrease the set duration.



SELECT DISPLAY USER PROFILE From the main menu use the up and right arrows to highlight the user profile, then press the "SELECT / ENTER" button.



The current user profile settings will be displayed. (Adjustments can not be made from this menu) Use the left or right arrow to check other user profile settings (user #1 or user #2). Press the "Select/Enter" button to select a different displayed user profile.



ADJUST INSTALLED OPTION SETTINGS

As options, a fan for heat circulation, fragrance pump for aromatherapy, and colored lights for chromatherapy can be installed and controlled using the remote control. To adjust the option settings, from the main menu use the up and right arrows to highlight the options icon, then press the “SELECT / ENTER” button.



EVENSTEAM™ FAN SPEED

The first option menu for the fan will appear as shown below.

Use the up or down arrow to change the number of bars highlighted which indicate fan speed. If this is the only option you wish to adjust press the “SELECT / ENTER” button to lock in the selection. To adjust other options, use the right arrow which takes you to the next option menu.

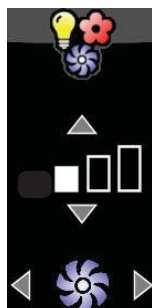

CHROMATHERAPY LIGHT OPTION

Use the up or down arrow to turn the chromatherapy light option on or off then use the right arrow to reach the menu that allows you to press the up arrow and scroll through the different light programs. Once the desired setting is reached press the “SELECT / ENTER” button to lock in the light selection and all previous option selections.



Note: When using multiple lights, periodic re-synchronization may be required. To reset synchronization, turn off lights for 5-7 seconds then turn back on. Lights should return to synchronization. When this has occurred your lights have been reset.

AROMATHERAPY FRAGRANCE INTENSITY

Use the up or down arrow to change the number of bars highlighted which indicates pump speed. If this is the only option you wish to adjust press the “SELECT / ENTER” button to lock in the selection, to adjust other options use the right arrow which takes you to the next option menu.

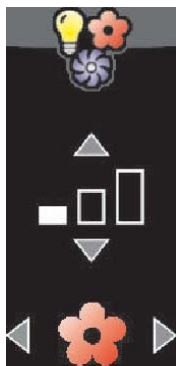

TOOL MENU

From the main menu use the right arrow to highlight the tool icon, then press the “SELECT / ENTER” button



The TOOL menu will be displayed as shown below.

Set user profile #1 or #2

60 min or 24hr duration maximum

Warm start on / off

Set clock and day of week

Re-sync remote to RF hub

SET CLOCK AND DAY OF WEEK

From the TOOL menu use the arrows to highlight the clock icon, then press the “SELECT / ENTER” button.



The set clock and day of week menu will be displayed as shown below.

The capital HH indicates the hour is ready to set by pushing the up or down arrow. Once the correct hour is set use the right arrow to select minute (the mm will change to MM) push the up or down arrow to set the correct minute. Continue using the right arrow to set AM/PM and Day of week. Once all the clock settings are correct push the “SELECT / ENTER” button to lock in the settings.

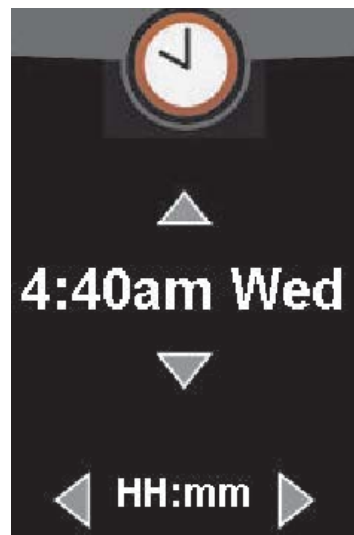

60 MINUTE OR 24 OUR DURATION MAXIMUM

The duration can be set in 5 minute increments up to 60 minutes (default setting) or 1 hour increments up to 24 hours. From the TOOL menu use the arrows to highlight the double hour glass icon, then press the “SELECT / ENTER” button.



The set duration increment menu will be displayed as shown below.

Use the left or right arrow to change the setting from minutes (5 min) to hours (1HR). Once the desired setting is displayed press the “SELECT / ENTER” button to lock in the setting.



WARM START ON / OFF

The warm start feature is only available for AK generators ordered with the warm start option. This option keeps the water in the steam tank at an elevated temperature (below boiling when steam bath is not in use) to provide faster steam production when the ON button is selected. To turn this feature on, use the arrows to highlight the warm start icon from the TOOL menu and press the “SELECT / ENTER” button.



The warm start on off menu will be displayed as shown below.

Use the up or down arrow to change the setting from off (as shown) to on. Once the desired setting is displayed press the “SELECT / ENTER” button to lock in the setting.



SET USER PROFILE #1 or #2

In addition to the default profile, 2 additional user profiles can be set controlling all the features on the main menu plus auto start times for week days Monday through Friday and weekends including Saturday and Sunday. To program the user profile, select the desired user number from the TOOL menu by highlighting the desired user and press the “SELECT / ENTER” button.



The adjustment menus for Duration, Temperature, Fan, Chromatherapy and Aromatherapy will be displayed in order by pushing the right arrow and are set the same as described previously.

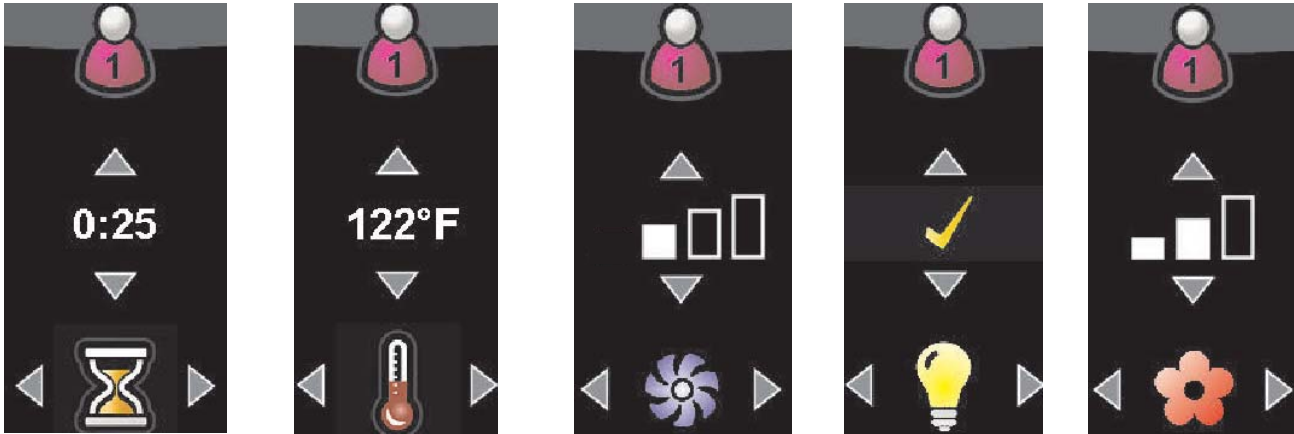

The auto start setting is adjusted by pressing the right arrow after the Chromatherapy menu and the menus below will be displayed in order. If the auto start feature is going to be used **it is important that the steam room door is closed during any programmed auto start cycle to avoid steam damage outside the steam room.**

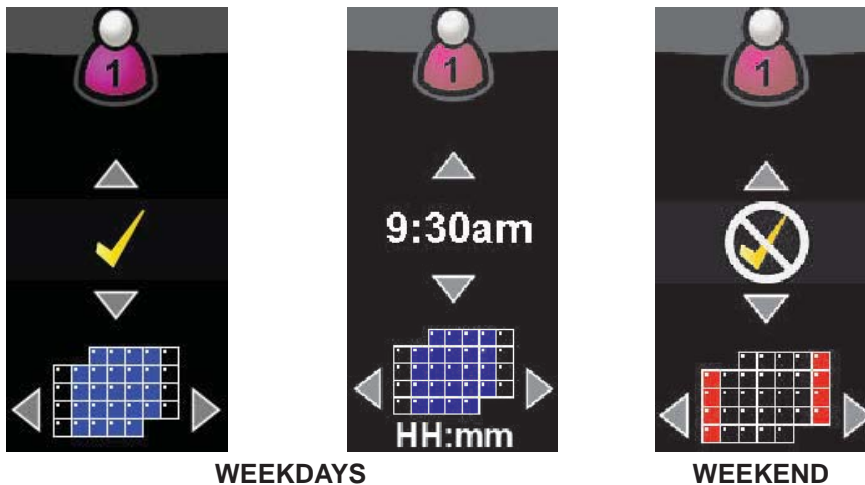

The auto start on / off is adjusted by using the up or down arrow, and the auto start time (hour, minute, am / pm) are adjusted in the same manner as setting the clock described above.

RE-SYNC REMOTE TO RF HUB

The re-sync function will likely never need to be used. However, if a component (remote, dock, rf hub or generator printed circuit assembly) needs replacement, re-syncing may be required. To re-sync, highlight the re-sync icon and press the select/enter button to go to the re-sync screen and press the select/enter button.



SECTION 3: REMOTE CONTROL DOCK

DOCK OPERATION

The **remote control dock** mounts inside the steam room, acts as a dock for the remote control, includes a built in temperature sensor, an on/off button for starting or stopping the steam bath (if the remote is not available) and a blinking LED light which indicates if the steam bath is on or off during the “on” cycle.

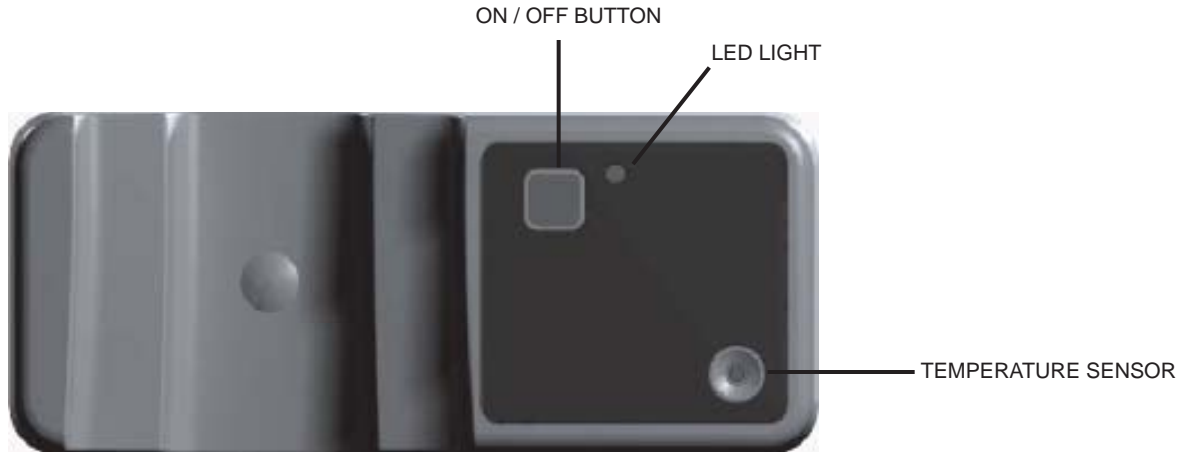

RE-SYNC DOCK TO RF HUB

If the remote control dock is replaced or the batteries are replaced. The dock may require re-syncing (remote control may not display steam room temperature). To re-sync the dock, press and hold the dock on/off button for several seconds until it begins to blink rapidly. This procedure should be performed within 4 minutes of turning the breaker power off and then back on to the steam generator.

DOCK MOUNTING

The remote control dock should be mounted inside the steam room 4 feet up from the floor not in the direct spray of the shower head and not directly over the steam head (over the steam head mounting will give the temperature sensor false readings). The dock mounts on the dock mounting plate which is attached to the steam room wall using either the adhesive gasket supplied or alternatively with mounting screws (not provided) for a permanent mounting (screws require pre-drilling holes into the steam-room wall material). Once the dock mounting plate is attached to the steam room wall, the remote control dock will slide down on to the dock mounting plate and lock in place. To remove the remote control dock simply slide the dock up and off of the mounting plate.

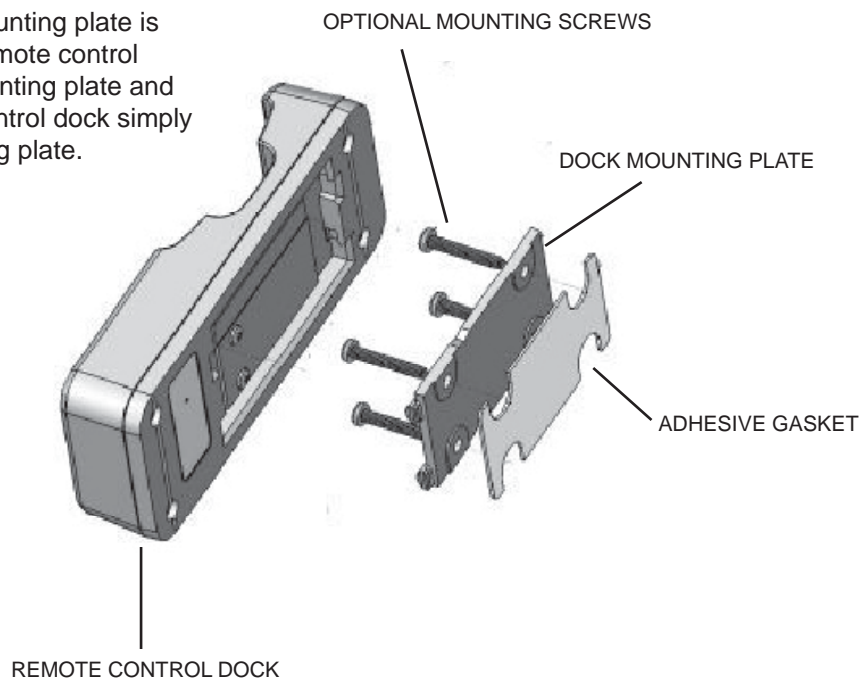

SECTION 4: RF HUB

RF HUB OPERATION

The **RF HUB** is connected to Jack J9 (marked wireless hub) on the printed circuit board inside the steam generator with a 25 foot cable. The hub relays signals to and from the remote control, remote control dock and the generator.

RF HUB MOUNTING

The **RF HUB** 25 foot cable allows mounting in multiple locations. Typically the mounting location should be high on a wall near or above the steam shower. The location should be indoors and dry. The mounting location should be tested to insure that signals from the remote control dock and locations where the remote control is planned to be used, receive a steady signal (no Red **X** appears on the display by any icon) and Steam room temperature is consistently displayed when the bath is on. RF Hub mounting locations with metal or metal studs between the remote, dock and hub should be avoided. See diagrams below for suggested RF Hub mounting.

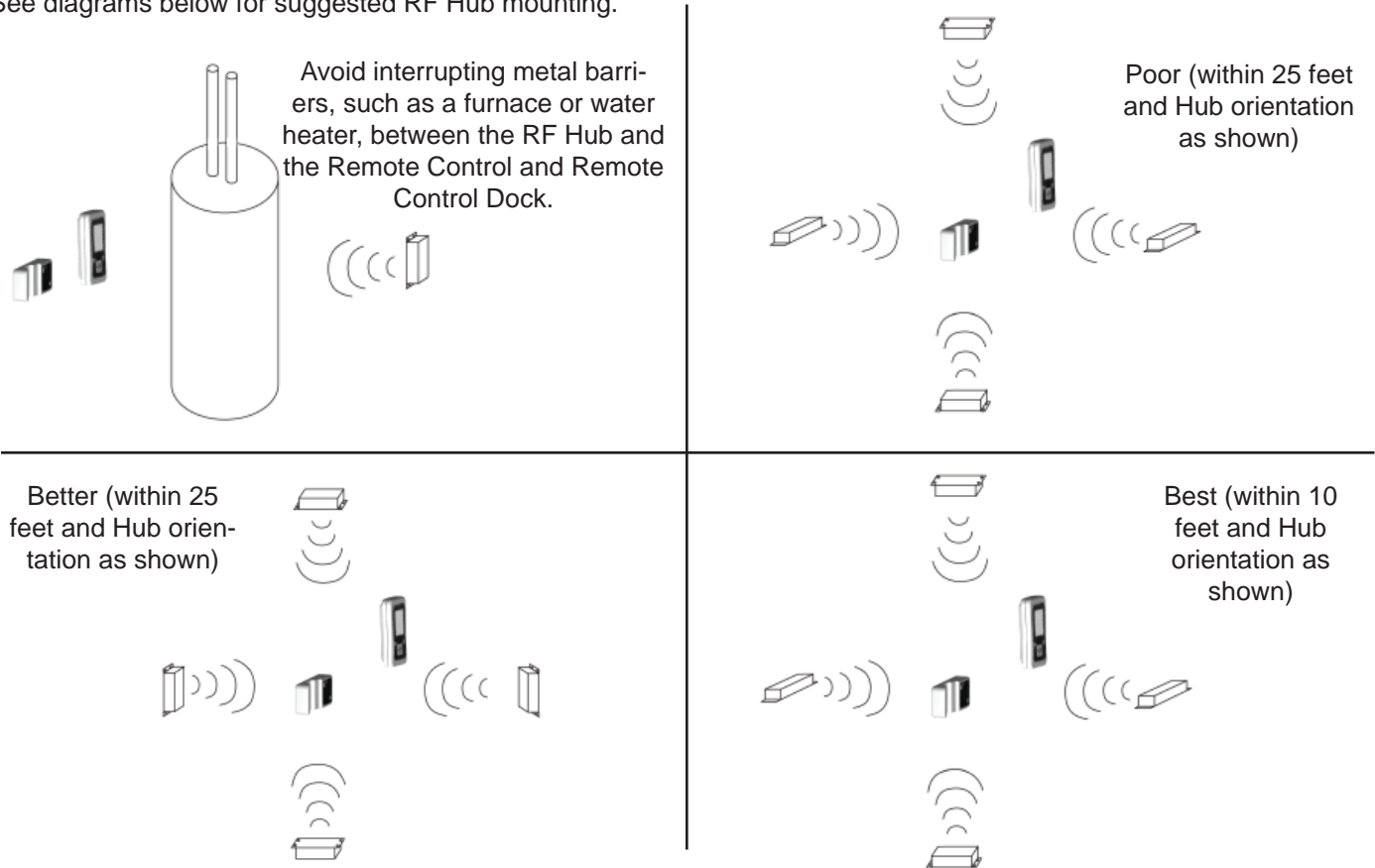

SECTION 5: REMOTE CONTROL CHARGING

The K200i comes with a 120 Volt charger for recharging the remote control battery. Simply connect the charger's power adapter to the charger and to a 120VAC outlet, then place the remote into the charger and the batteries will be fully recharged in approximately 4 hours.

When the remote is first placed in the charger, its display may light for a short period. The charger has an indicator light which will light while the remote is charging. Once the remote is fully charged, this light will go out.

Be careful to keep the charger dry. Excessive moisture from charging a wet remote or using the charger in a wet area may damage the charger. For proper operation, the charging pins should be clean, dry and move freely when pressed.

SECTION 6: BATTERY REPLACEMENT

REMOTE CONTROL

The remote control battery is rechargeable. If battery ever needs replacement, contact support at 1-800-363-0251 to order battery replacement kit. To change battery, remove 6 screws on back of battery cover, unplug battery by pulling on connector (not wire). Install new battery and replace gasket and replace battery cover.



REMOTE CONTROL DOCK

To replace remote control dock battery, call 1-800-331-0349 to order battery replacement kit. To change battery, remove 7 screws on back of remote control dock, remove old and replace with new battery, replace gasket and replace back of remote control dock.

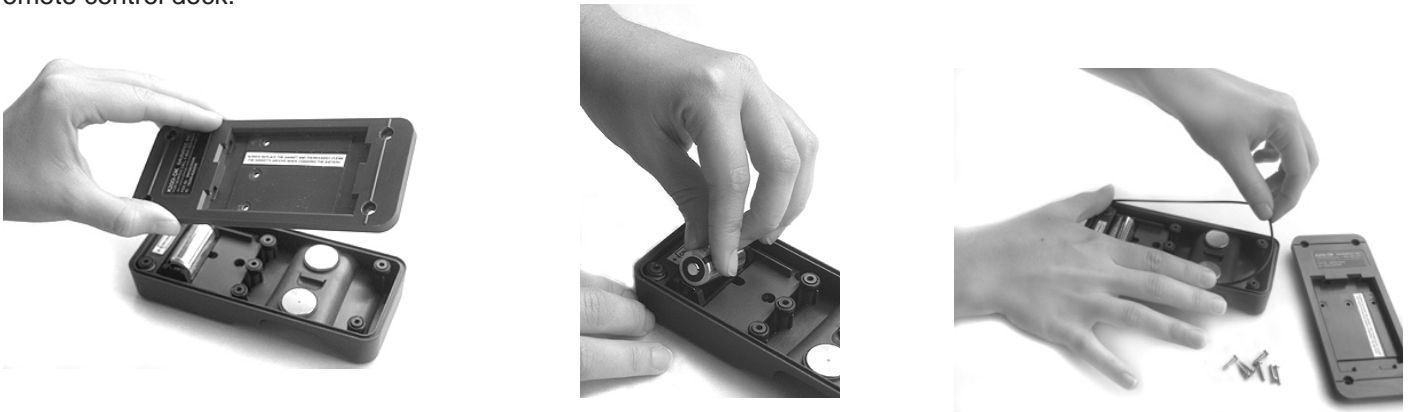

SECTION 7: DISABLING OPTION DISPLAY

If an option (Chromatherapy Lighting, Fragrance Injector Pump, or EvenSteam™ Air Circulation Fan) is not installed, you have the ability to prevent the remote control display from showing these menu items. To disable the option icons/menus from appearing on the display, set the jumpers over the option pins on the printed circuit board inside the generator as shown below.

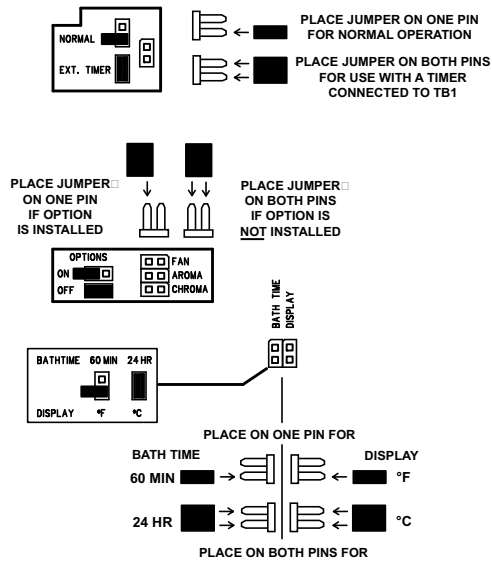

SECTION 8: TAKING A STEAMBATH

1. Wait for the steam room to reach a comfortable temperature.
2. Remove clothing and jewelry.
3. Enter the steam room and close the door to prevent steam from escaping.
4. Relax and enjoy the warm steam releasing tense muscles and refreshing the entire body.
5. If your steam room has a shower, a pleasant experience can be achieved by taking a warm shower with the steam.
6. After a steam bath, a warm shower will give you a feeling of relaxation and is conducive to a good night's rest. A cold shower will refresh you and is a good way to start a busy day or prepare you for an evening out.

SECTION 9: MAINTENANCE OF YOUR AK STEAM GENERATOR

The steam generator, steam head, fittings and plumbing connections should be inspected regularly for water leaks and damage. The AK steam generator is equipped with a manual drain valve for flushing sediments from the generator tank. This procedure should be scheduled monthly or more often depending on local water conditions and steam bath usage, (if an optional auto drain valve has been installed, this maintenance step may be skipped).

Flushing Procedures:

1. The generator should be cool.
2. Press the control ON.
3. Open the manual drain valve.
4. The unit will drain without heating the water.
5. Allow the water to run for a full 10 minutes.
6. Push the control OFF. When the water stops flowing out the drain, close the manual drain valve.

SECTION 10: TROUBLE SHOOTING GUIDE

The troubleshooting guide is meant as a general aid only. There are no user serviceable parts in the generator. All repairs should be performed by a qualified service person. For additional assistance or the factory authorized service person nearest you call: Technical Support at **1-800-363-0251**.

SYMPTOMS	PROBABLE CAUSES	ACTION TO BE TAKEN
Control won't turn "ON". (Control light off).	Improper power supplied (no power). or Control improperly connected. or Control is faulty.	<ol style="list-style-type: none"> 1. a. Make sure circuit breaker is "ON". b. Using a voltmeter, check the voltage across the two fuses on the "PCA" printed circuit assembly. Voltage should be 208V/240V. c. Check fuses, if the fuse(s) are blown, replace with 100mA Time Delay (F1) or 1A Non-Time Delay (F2) or equivalent fuse. If the fuse blows again - call Amerec's Technical Support. <ol style="list-style-type: none"> 2. Replace the control - call Amerec's Technical Support.
Control "OFF". Unit still makes steam.	Generator is faulty.	<ol style="list-style-type: none"> 1. Turn off the circuit breaker. 2. Call Amerec's Technical Support.
Water runs out of steam head.	Generator is faulty.	<ol style="list-style-type: none"> 1. Turn off the circuit breaker. 2. Turn off the water. 3. Call Amerec's Technical Support.
Steam room too hot or cold.	Temperature adjustment needs setting.	<ol style="list-style-type: none"> 1. See Section 2, "SET TEMPERATURE". 2. Call Amerec's Technical Support.
Control won't turn "OFF". (Control light on).	Control is faulty.	<ol style="list-style-type: none"> 1. Replace the control - call Amerec's Technical Support.
Control "ON". (Control display on) Unit won't steam.	Unit has not filled completely. or Generator is faulty.	<ol style="list-style-type: none"> 1. Wait at least 10 minutes after turning on the control. 2. Call Amerec's Technical Support.
Sudden increases in rate water sputters out of steam head.	Foaming contaminants in the water supply.	<ol style="list-style-type: none"> 1. Flush tank 3 times. See Section 9.

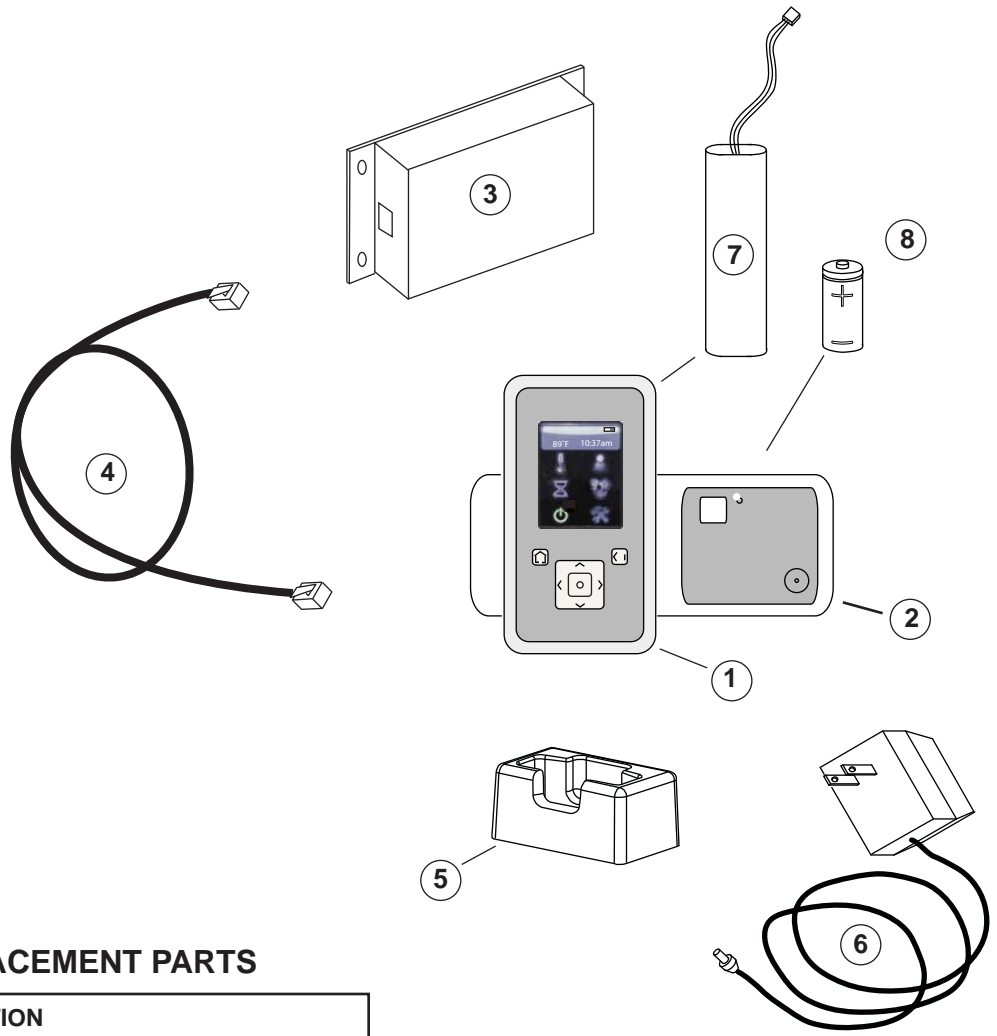

REPLACEMENT PARTS

ITEM	DESCRIPTION
1	K200i REMOTE CONTROL
2	REMOTE CONTROL DOCK
3	RF HUB
4	RF HUB CABLE, 25'
5	CHARGER, REMOTE
6	CHARGER POWER ADAPTER, 120VAC
7	REPLACEMENT BATTERY, REMOTE
8	REPLACEMENT BATTERY, DOCK

amerec

P.O. Box 2258, Woodinville WA 98072

Phone 1-800-363-0251

Fax: 425-951-1130

email: support@amerec.com